

Wenzhou Safewire Electric CO.,Ltd.

SPECIFICATION SHEET

PRODUCT NAME: underfloor socket

PRODUCT No. :

HTD-624AS-B



HTD-624B

Address:2nd floor, Wealth Garden, Liushi town, Yueqing, Wenzhou,China ,325604

Tel:0086-577-61725369

Mob:0086-18612380398

ZIP:325604

(E-mail) : happyhe@safewirele.com

(WEB): <http://www.safewirele.com>

Technical parameters & characteristic :

1) Working environment:

1. The environment temperature:-5°C~/40°C
2. The rated voltage： 100V~~250V
3. The rated current： 10A、 13A、 16A、 20A

2) Technical parameters :

Serial No.	Parameter	Description
1	Type	HTD-624AS-B
2	Panel materials	Plastic
3	Material of bottom box	A).Plastic; B).Plastic with additional stainless steal HTD-624AS-B
4	Overall Frame & Lid (mm)	244.3*223.5
5	Compact floor cut-out(mm)	(210-215)*(230-235)*(76-110)
6	Thickness of concavity/Frame lid recess (mm)	8
7	Installation depth(mm)	76~110
8	Plug top clearance(mm)	13~48
9	Available modules	12 modules
10	Accessories plates	90*80mm
11	G.W.	14.2KG/Carton
12	N.W.	13.2KG/Carton

Application :

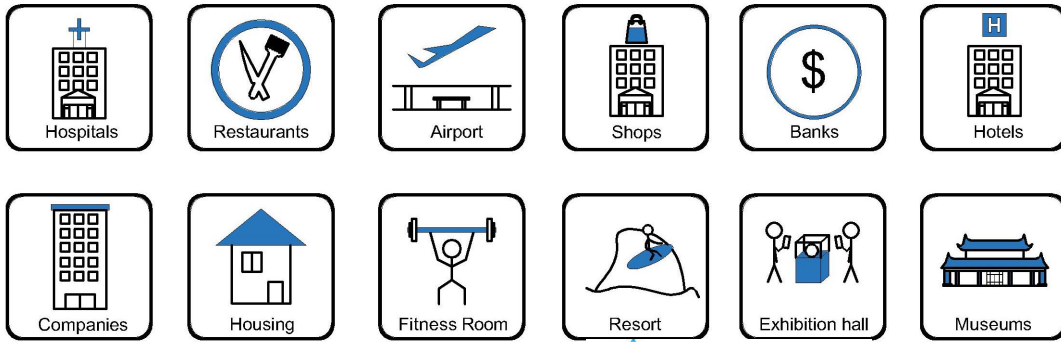

Safewire product range is applied for concrete floor /raised floor/access floor; carpet, rubber, Material and wooden floor are suggested. Filling material is same as floor material.

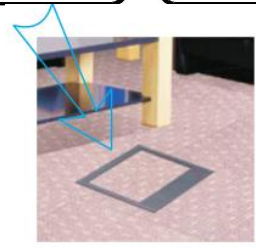

Product Show:



Features:

Our floor boxes are boxes for installation recessed in floor with possibilities of add decorative materials like carpet, parquet or other finishes, on the lid.





















1. **Perfect finish:**Our range of access and screed Floor Boxes are available with 1, 2, 3 or 4 compartments and Blends in fully with the surroundings
2. **Safety guaranty:**Frame & lid moulded from high impact ABS plastic material and self-extinguishing, halogen-free materials, guaranty of safety for people and equipment.
3. **Protected opening system:** Easy grip recessed lifting handle and only be opened by pulling both opening clips at the same time. The clips of floor boxes are self-positioning and secure the fastening.
4. **Easy installation:** Clamp fixing of receptacle and Data outlet for fast installation.No junction box is required for installing floor boxes in raised floors.
5. The carpet protective frame is overlapping the edge of the floor and is to protect the carpet material against fraying at the edge.
6. Add the galvanized sheet bottom box, it can use in concrete floor.

Available sockets or modules types:

1).45 type modules

SAFEWIRE

45 Type Function Accessories

								
F2	F3	F4	F11	F15	F16	F18		
								
F20/F21/F22/F23/F25/F28	F50	F51	F52	F53	F55	F56	F58	F59
								
F60	F62	F65/F66/F67/F68	F68	F71				



3) .86 type socket

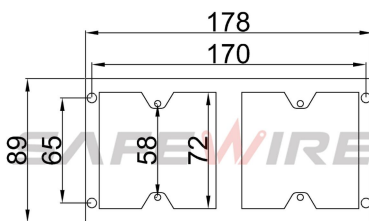

3).120 type socket

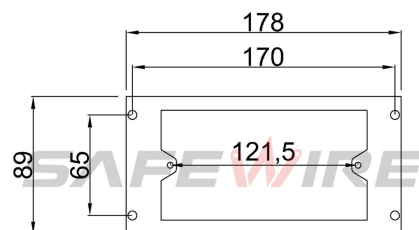

HTD-624AS Outline drawing

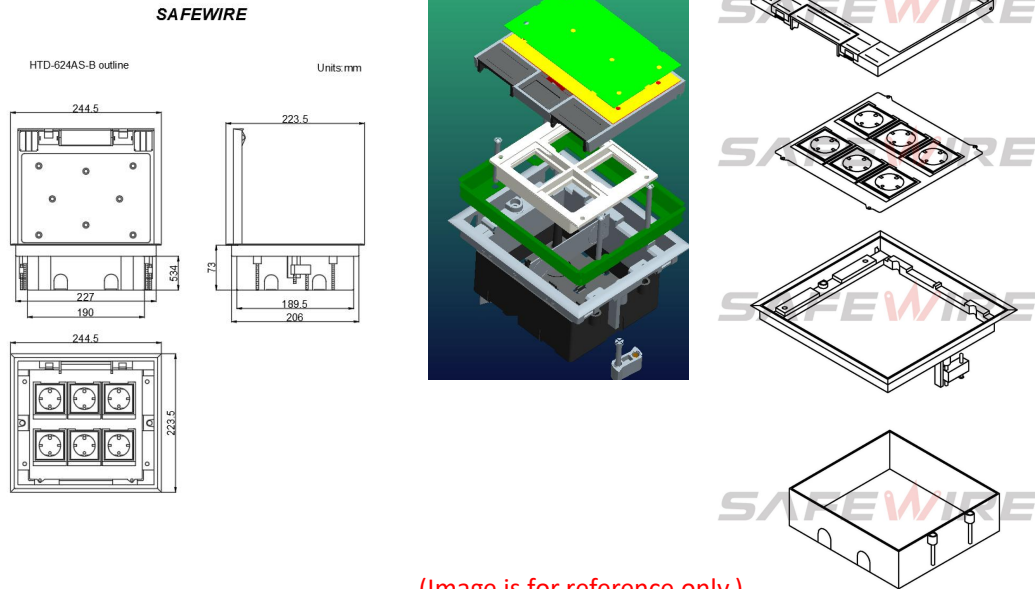

Filling bit size: 214X163mm
 Filling height: max ≥8mm
 Iron plate size: 212X161X4mm



Package:12 Pcs inner box into a master carton.Poly bag with box packing.



Only with polyfoam



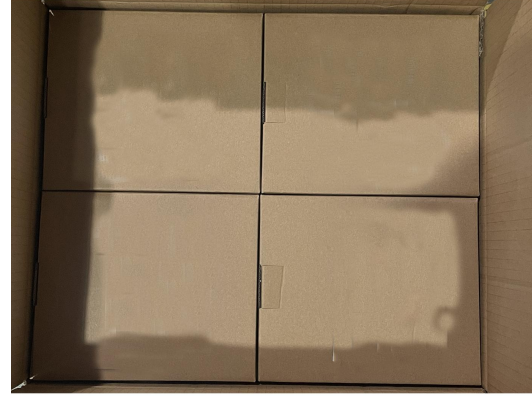

Polyfoam with additional inner

SafeWire

Package solution



Access floor socket



Socket with Plastic film



boxes with polyfoam

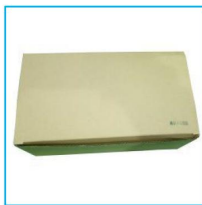

Socket with kraft paper



Socket into inner box



Put to pallet

Installation instructions:

1.For raised floor

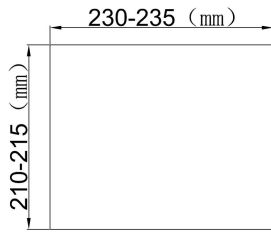

CUT OUT SIZE

Installation depth(mm): 76--110
 Plug top clearance(mm): 14-48

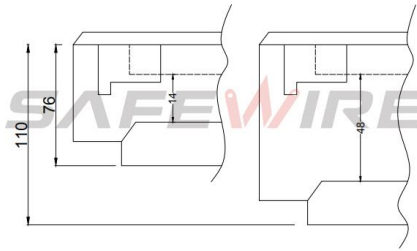

(1)

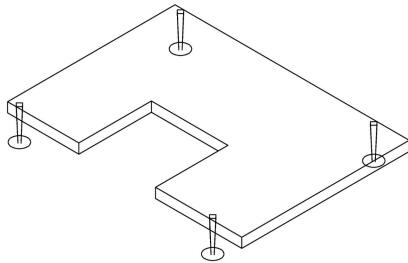

(2)

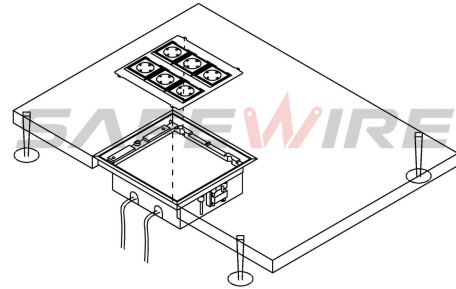

(3)

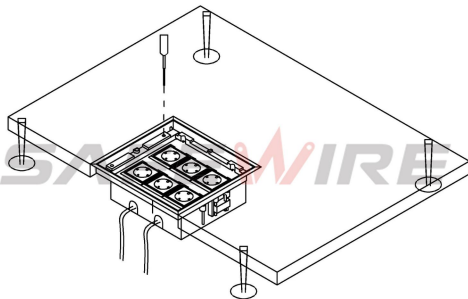

(4)

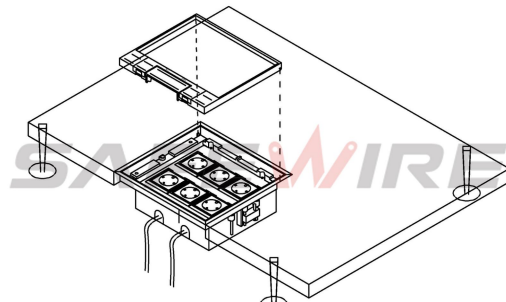

(5)

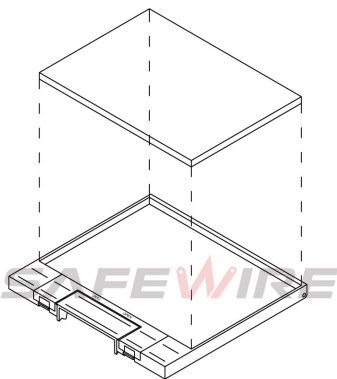

(6)

(7)

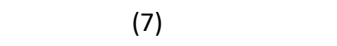

2. For screed floor

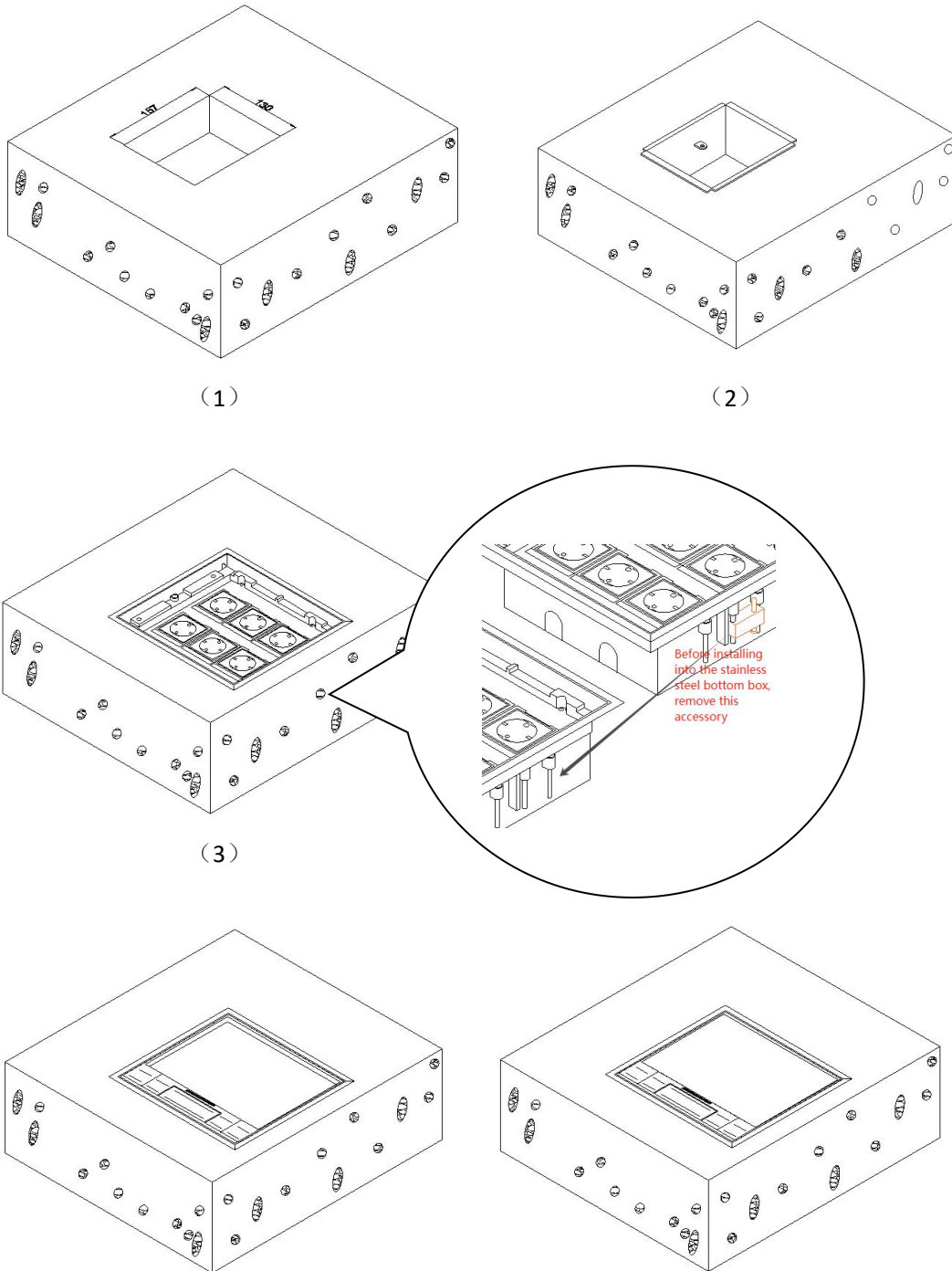

INSTALLATION

Important: Installation works can only be carried out by professional electricians with skill certificates issued accordingly to local health and safety regulations!

1. Prepare a hole in the floor corresponding to the installation dimensions of a given model
2. Detach the cover from the box, and then unscrew the mounting frame of the modules.
3. Install the modules of your choice into the mounting frame .
4. Pull all necessary wires through the floor box and connect the modules to the wires.
5. Screw the mounting frame with installed modules to the floor box .
6. Place the box with the sockets in the previously prepared hole.
7. Adjust the height of the box and the module frame using the screws on the side of the unit .
8. Tighten the box to the floor using the screws on the side of the unit .
9. Install the cover of the box back into the hinges .
10. Cut the floor material matching the recess in the cover and glue it to the cover

CLEANING AND MAINTENANCE

Any maintenance work must be done when the product is disconnected from power supply. Clean only with soft and dry cloths. Do not use chemical detergents.

Attentions:

- 1.Dispose of trash in bottom box and prevent dirt and debris from entering inside.
- 2.The sealing ring is closely attached to the smooth surface to prevent water leakage.
- 3.When installing, pay attention to the opening direction,the length of the conductor to the bottom box shall not exceed 10cm,Set aside at least 200mm of cable.
- 4.When installing and wiring,Product should avoid direct contact with corrosive liquid, gas (strong acid, strong alkali, paint).
- 5.Please close cover when not used.
- 6.Panel rounded corners are not easily damaged during transportation

Safety Warning:

- 1.This is a class I product and must be earthed
- 2.This product must be installed/wired by a qualified electrician
- 3.For indoor use only.
- 4.For concrete floor/access floor.base on different bottom box.